

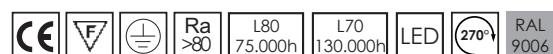

NANO-PRINCE



Proiettore per interni ed esterni.
 Corpo in alluminio trafilato ossidato, vetro temperato trasparente spessore 5 mm, guarnizione in silicone, alimentatore elettronico 230V.
 Prodotto in conformità alle vigenti norme EN / IEC 60598-1:2008.

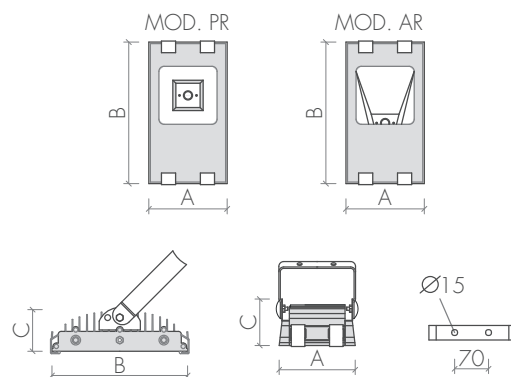

Indoor and outdoor floodlight.
 Body, trafilated aluminium oxydate, tempered transparent glass mm 5 thickness, silicon gasket, electronic ballast 230V.
 Rules: fittings manufactured according to the EN / IEC 60598-1:2008 rules.

DIMENSIONS

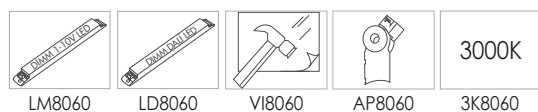

OPTIONS



| | A | B | C | Kg | mc |  |  |
|----|-----|-----|-----|-----|-------|---|---|
| D1 | 155 | 280 | 100 | 3,1 | 0,007 | 1 | 50 |



mod/PR

Optiche e diffusori

Riflettore simmetrico in alluminio satinato.

Louvers and diffusers

Matt satin symmetric aluminium reflector.

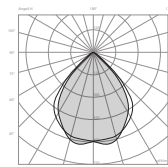

IP65 850° IK08

| Cod. | W-Tot. | % | Lm (Tc=25°) | Lm (Output) | Dimension |
|--------------|--------|------|-------------|-------------|-----------|
| 8060PR4030EL | 30 | 4000 | 4404 | 3526 | D1 |
| 8060PR5030EL | 30 | 5000 | 4449 | 3570 | D1 |
| 8060PR4040EL | 40 | 4000 | 5792 | 4640 | D1 |
| 8060PR5040EL | 40 | 5000 | 5851 | 4693 | D1 |
| 8060PR4050EL | 50 | 4000 | 7015 | 5620 | D1 |
| 8060PR5050EL | 50 | 5000 | 7086 | 5685 | D1 |



mod/AR

Optiche e diffusori

Riflettore asimmetrico in alluminio satinato.

Louvers and diffusers

Matt satin asymmetric aluminium reflector.

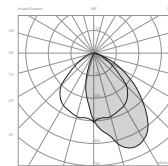

IP65 850° IK08

| Cod. | W-Tot. | % | Lm (Tc=25°) | Lm (Output) | Dimension |
|--------------|--------|------|-------------|-------------|-----------|
| 8060AR4030EL | 30 | 4000 | 4404 | 3319 | D1 |
| 8060AR5030EL | 30 | 5000 | 4449 | 3360 | D1 |
| 8060AR4040EL | 40 | 4000 | 5792 | 4367 | D1 |
| 8060AR5040EL | 40 | 5000 | 5851 | 4417 | D1 |
| 8060AR4050EL | 50 | 4000 | 7015 | 5289 | D1 |
| 8060AR5050EL | 50 | 5000 | 7086 | 5351 | D1 |