

# RIGA

ARCHITETTURALI - ARCHITECTURAL LIGHT FITTINGS

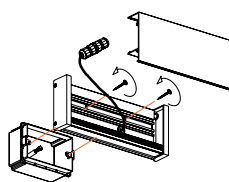

Interasse fori fissaggio compatibili con scatola incasso 3 moduli 503

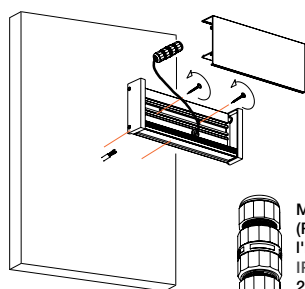

Manutenzione rapida e senza utilizzo di attrezzi  
Quick and tool-free maintenance



Morsetteria 3x2,5mm<sup>2</sup> (Riga 120 e Riga 220) e 2x2,5mm<sup>2</sup> (Riga 380) IP68 per cavi Ø5mm - Ø14mm per facilitare l'installazione del prodotto  
IP68 terminal block 3x2,5mm<sup>2</sup> (Riga 120 and Riga 220) and 2x2,5mm<sup>2</sup> (Riga 380) for cable Ø5mm - Ø14mm for an easy installation



## Facile da installare

Riga è già pronto per la sua installazione a parete. Basta semplicemente fissare con due viti il corpo e collegare il cavo al connettore. Non resta che inserire la sua copertura

## Easy to install

Riga is all set to be wall mounted. Simply fix the body with two screws and connect the cable to the connector. Apply the front cover

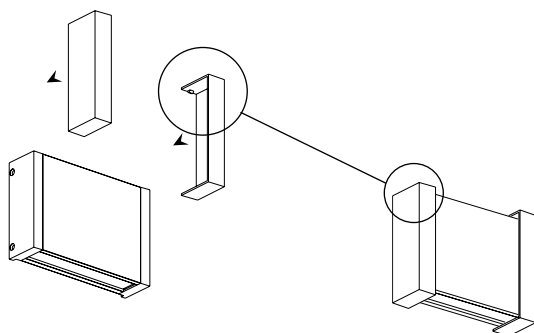

## Testate decorative a corredo

In dotazione due testatine ad incastro per un'alternativa estetica

## Decorative side heads

Two interlocking side heads are included with Riga as optional accessories

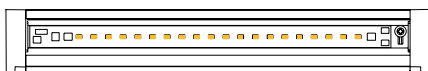

## Resinatura

Processo di resinatura delle barre a led tramite resina poliuretana bianca dalle caratteristiche inalterabili nel tempo: protezione IP67 e stabile contro i raggi UV (protezione contro l'ingiallimento)

## Resin sealing

LED's bars sealed with non-wearing white polyurethane resin, IP67 rated, UV-stabilized (non-yellowing)

## Verniciatura

Ciclo produttivo di verniciatura con tecnologia di pre-trattamento flash di ossidazione anodica. Tale trattamento può garantire resistenze superiori alla corrosione e al degrado atmosferico

## Painting

Coating process through pre-treating system using anodic oxidation. This system guarantees higher protection against corrosion and atmospheric agents

## Esecuzioni speciali

L'ufficio tecnico è a disposizione per analizzare soluzioni fuori standard per potenza, lumen e lunghezza

Le esecuzioni speciali partono da Riga 380 a step di 5cm di lunghezza

## Customizations

Mareco Luce technical department is available to study the most suitable customizations by analysing power and Lm needs.

Possible customization starting from Riga 380 with steps of 5cm of length

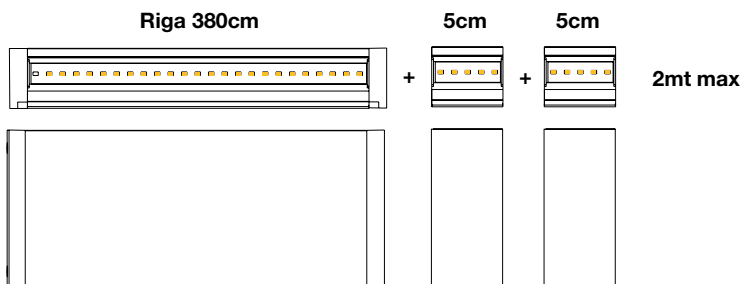

## Una gamma completa

Che sia mono o bi emissione, asimmetrica con o senza schermo, corta o più lunga, la facilità di installazione rimane la stessa

## A complete range

Riga is extremely easy to install, whether it is in 1 light, 2 lights or asymmetrical - with or without diffuser - your work is the same.

## Versatile e personalizzabile

Riga consente al progettista/installatore, infinite possibilità di applicazione, ottimizzando così ogni specifica esigenza di utilizzo

## Main features

Riga is an extremely flexible luminaire, offering unlimited design solutions

# RIGA 120

ARCHITETTURALI - ARCHITECTURAL LIGHT FITTINGS



## LED

5W - 4000K - **465 lm** - 220-240V 50/60Hz  
 5W - 3000K - **465 lm** - 220-240V 50/60Hz  
 10W - 4000K - **930 lm** - 220-240V 50/60Hz  
 10W - 3000K - **930 lm** - 220-240V 50/60Hz

- B Bianco - White
- Grigio metallizzato - Metallic grey
- Corten - Rust
- Antracite - Anthracite



CE IP67 - IK08



Sistema lineare per utilizzo diretto a parete  
 Pre-foratura per fissaggio a parete, compatibile con scatole incasso universali 3 moduli  
 Circuito led ad allacciamento diretto alla rete senza driver  
 Processo di resinatura delle barre a led tramite resina poliuretanicca bianca  
 Schermo in acrilico trasparente opacizzato (versione asimmetrica)  
 Corpo in alluminio estruso anodizzato e verniciato  
 Carter di copertura in alluminio estruso anodizzato e verniciato  
 Barra led in alluminio estruso anodizzato e verniciato  
 Viteria in acciaio inox A2  
**Testate decorative**  
 Testatine laterali ad incastro in tecnopolimero rinforzato e verniciato

Architectural luminaire for wall application  
 Pre-set fixing holes  
 Mains supplied LED's circuit without driver  
 LED's bars sealed with non-wearing white polyurethane resin  
 Translucent PMMA (acrylic) diffuser (asymmetriv version)  
 Anodized and painted extruded aluminium body (base and front cover)  
 Anodized and painted extruded aluminium LED's bar  
 A2 stainless steel screws  
**Decorative side heads**  
 Interlocking side heads in painted reinforced thermoplastic

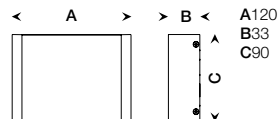
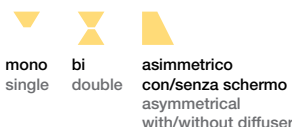

### MONO EMISSIONE - SINGLE EMISSION

Dimensioni Dimensions	Potenza Power	Colore Colour	Codice Code	
120x33x90mm	5W 4000K 465 lm	<span style="border: 1px solid black; padding: 2px;">B</span>	0230.182B	1
120x33x90mm	5W 3000K 465 lm	<span style="border: 1px solid black; padding: 2px;">B</span>	0230.184B	1
120x33x90mm	5W 4000K 465 lm	<span style="background-color: #cccccc; border: 1px solid black; padding: 2px;"></span>	0230.182M	1
120x33x90mm	5W 3000K 465 lm	<span style="background-color: #cccccc; border: 1px solid black; padding: 2px;"></span>	0230.184M	1
120x33x90mm	5W 4000K 465 lm	<span style="background-color: #a52a2a; border: 1px solid black; padding: 2px;"></span>	0230.182J	1
120x33x90mm	5W 3000K 465 lm	<span style="background-color: #a52a2a; border: 1px solid black; padding: 2px;"></span>	0230.184J	1
120x33x90mm	5W 4000K 465 lm	<span style="background-color: #666666; border: 1px solid black; padding: 2px;"></span>	0230.182S	1
120x33x90mm	5W 3000K 465 lm	<span style="background-color: #666666; border: 1px solid black; padding: 2px;"></span>	0230.184S	1



mono - single

### BI EMISSIONE - DOUBLE EMISSION

Dimensioni Dimensions	Potenza Power	Colore Colour	Codice Code	
120x33x90mm	10W 4000K 930 lm	<span style="border: 1px solid black; padding: 2px;">B</span>	0231.182B	1
120x33x90mm	10W 3000K 930 lm	<span style="border: 1px solid black; padding: 2px;">B</span>	0231.184B	1
120x33x90mm	10W 4000K 930 lm	<span style="background-color: #cccccc; border: 1px solid black; padding: 2px;"></span>	0231.182M	1
120x33x90mm	10W 3000K 930 lm	<span style="background-color: #cccccc; border: 1px solid black; padding: 2px;"></span>	0231.184M	1
120x33x90mm	10W 4000K 930 lm	<span style="background-color: #a52a2a; border: 1px solid black; padding: 2px;"></span>	0231.182J	1
120x33x90mm	10W 3000K 930 lm	<span style="background-color: #a52a2a; border: 1px solid black; padding: 2px;"></span>	0231.184J	1
120x33x90mm	10W 4000K 930 lm	<span style="background-color: #666666; border: 1px solid black; padding: 2px;"></span>	0231.182S	1
120x33x90mm	10W 3000K 930 lm	<span style="background-color: #666666; border: 1px solid black; padding: 2px;"></span>	0231.184S	1



bi - double

### ASIMMETRICO SENZA SCHERMO - ASYMMETRICAL WITHOUT DIFFUSER

Dimensioni Dimensions	Potenza Power	Colore Colour	Codice Code	
120x33x90mm	5W 4000K 465 lm	<span style="border: 1px solid black; padding: 2px;">B</span>	0232.182B	1
120x33x90mm	5W 3000K 465 lm	<span style="border: 1px solid black; padding: 2px;">B</span>	0232.184B	1
120x33x90mm	5W 4000K 465 lm	<span style="background-color: #cccccc; border: 1px solid black; padding: 2px;"></span>	0232.182M	1
120x33x90mm	5W 3000K 465 lm	<span style="background-color: #cccccc; border: 1px solid black; padding: 2px;"></span>	0232.184M	1
120x33x90mm	5W 4000K 465 lm	<span style="background-color: #a52a2a; border: 1px solid black; padding: 2px;"></span>	0232.182J	1
120x33x90mm	5W 3000K 465 lm	<span style="background-color: #a52a2a; border: 1px solid black; padding: 2px;"></span>	0232.184J	1
120x33x90mm	5W 4000K 465 lm	<span style="background-color: #666666; border: 1px solid black; padding: 2px;"></span>	0232.182S	1
120x33x90mm	5W 3000K 465 lm	<span style="background-color: #666666; border: 1px solid black; padding: 2px;"></span>	0232.184S	1



asimmetrico senza schermo asymmetrical without diffuser

### ASIMMETRICO CON SCHERMO - ASYMMETRICAL WITH DIFFUSER

Dimensioni Dimensions	Potenza Power	Colore Colour	Codice Code	
120x33x90mm	5W 4000K 465 lm	<span style="border: 1px solid black; padding: 2px;">B</span>	0233.182B	1
120x33x90mm	5W 3000K 465 lm	<span style="border: 1px solid black; padding: 2px;">B</span>	0233.184B	1
120x33x90mm	5W 4000K 465 lm	<span style="background-color: #cccccc; border: 1px solid black; padding: 2px;"></span>	0233.182M	1
120x33x90mm	5W 3000K 465 lm	<span style="background-color: #cccccc; border: 1px solid black; padding: 2px;"></span>	0233.184M	1
120x33x90mm	5W 4000K 465 lm	<span style="background-color: #a52a2a; border: 1px solid black; padding: 2px;"></span>	0233.182J	1
120x33x90mm	5W 3000K 465 lm	<span style="background-color: #a52a2a; border: 1px solid black; padding: 2px;"></span>	0233.184J	1
120x33x90mm	5W 4000K 465 lm	<span style="background-color: #666666; border: 1px solid black; padding: 2px;"></span>	0233.182S	1
120x33x90mm	5W 3000K 465 lm	<span style="background-color: #666666; border: 1px solid black; padding: 2px;"></span>	0233.184S	1



asimmetrico con schermo asymmetrical with diffuser