

GRUS

BOLLARD - BOLLARDS

LED

3.5W - 4000K - **300 lm** - 220-240V 50/60Hz
 3.5W - 3000K - **270 lm** - 220-240V 50/60Hz
 2x1.5mm² H07RN-F (1mt)

RGB

9W - full color - 350mA
 6x0.25mm² PVC (1mt)

 Satinato - Brushed





Apparecchio decorativo "tuttaluce" ad incasso pavimento con controcassa obbligatoria
 Aste luminose cilindriche in acrilico trasparente satinato Ø20mm, altezza 850mm, 1000mm, 1150mm con terminale smussato a 30°
 Corpo in pressofusione di alluminio anodizzato
 Controcassa in tecnopolimero rinforzato
 Viteria in acciaio inox A2

Decorazione
 Cornice in acciaio inox lucidata



CE  IP67 - IK08

A+

Dimensioni Dimensions	Potenza Power	Colore Colour	Codice Code	
Ø200x1155mm	3.5W 4000K 300 lm		CL901480	1
Ø200x1155mm	3.5W 3000K 270 lm		CL901471	1
Ø200x1155mm	9W RGB		CL901675	1

ACCESSORI - ACCESSORIES

Controcassa - Recessed box	Ø190x270mm	7000.0002	1
Morsettiera IP68 - IP68 connection	Pag.150	CS093000	1
Morsettiera "T" IP68 "T"-3way IP68 connection	Pag.150	CS093001	1

ACCESSORI OBBLIGATORI LED RGB COMPULSORY ACCESSORIES LED RGB

Generatore DMX - DMX generator	Pag.152	CS180001	1
Controller DMX - DMX controller	Pag.152	CS180006	1
Kit cavo 6 poli - Kit 6 pole	Pag.152	CS180007	1

Generatore DMX 350mA DMX generator 350mA CS180001	Controller DMX 350mA DMX controller 350mA CS180006	Kit cavo connessione 6 poli Connection kit cable 6 poles CS180007
•	max 4	•

Recessed decorative "total light" fitting with three rods, requiring recessed box
 Brushed transparent PMMA (acrylic) luminous rods Ø20mm, height 850mm, 1000mm, and 1150mm, with top cut at 30° angle

Anodised die-cast aluminium body
 Reinforced thermoplastic recessed box
 A2 stainless steel screws

Decorative cover
 Polished stainless steel cover

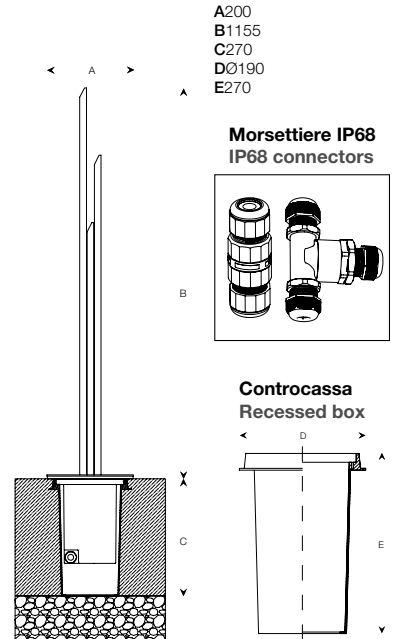

STICK

BOLLARD - BOLLARDS

LED

3W - 4000K - **217 lm** - 700mA
 3W - 3000K - **191 lm** - 700mA
 2x0.5mm² H05RN-F (1mt)

 Satinato - Brushed



Apparecchio decorativo cilindrico per fissaggio diretto a terreno tramite picchetto
 Driver remoto
 Aste luminose cilindriche in acrilico trasparente satinato Ø20mm, 1000mm con terminale smussato a 30°

Corpo in alluminio anodizzato e verniciato
 Picchetto in tecnopolimero rinforzato
 Viteria in acciaio inox A2



CE  IP67 - IK08

A+

Dimensioni Dimensions	Potenza Power	Colore Colour	Codice Code	
Ø20x1280mm	3W 4000K 217 lm		4010.182N	1
Ø20x1280mm	3W 3000K 191 lm		4010.184N	1

ACCESSORI - ACCESSORIES

Alimentatore elettronico 700mA 8W IP20 Electronic driver 700mA 8W IP20	Pag.150	CS160014	1
Alimentatore elettronico 700mA 33W IP20 Electronic driver 700mA 33W IP20	Pag.150	CS160020	1

Alimentatore elettronico Electronic driver 700mA 8W CS160014	Alimentatore elettronico Electronic driver 700mA 33W CS160020
min 1 - max 2	min 4 - max 12

Decorative cylindrical fitting for direct fixing into the ground through a spike
 Electronic driver (remote, to be ordered separately)
 Brushed transparent PMMA (acrylic) luminous rod Ø20mm, height 1000mm, with top cut at 30° angle

Anodised and painted aluminium body
 Reinforced thermoplastic spike
 A2 stainless steel screws

