



Dracma 140



CE Conforme alle direttive UE

Colori:

Inox

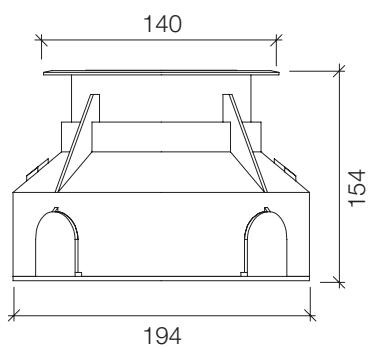

Dati tecnici

- Guarnizioni in silicone
- Viteria in acciaio inox A2
- Gruppo ottico basculabile $\pm 15^\circ$
- Carrabile: 2000kg, 20km/h

Cornice

- Cornice tonda in acciaio inox

Diffusore

- Diffusore in vetro piano temperato trasparente spessore 8mm

Ottica

- Flood

Corpo

- Corpo in pressofusione di alluminio anodizzato
- Pressacavo plastico PG9

Controcassa inclusa

- Controcassa in tecnopolimero rinforzato circolare $\varnothing 194 \times 152$ mm con chiusura inferiore e superiore per agevolare la cementazione

Accessori opzionali per l'installazione (da ordinare separatamente)

- Morsettiera Ilineare IP68
- Morsettiera "T" IP68

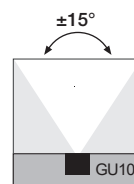

Ottica orientabile



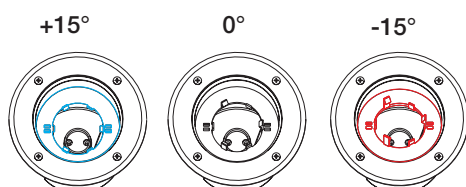

Potenza	Codice	
max 35W - GU10	5140.181G	1

Accessori opzionali per l'installazione	Codice	
Morsettiera Ilineare IP68	CS093000	1
Morsettiera "T" IP68	CS093001	1

Ottica basculabile $\pm 15^\circ$



Dracma 140

Attacco lampada	Gradi di protezione IP	IK	Classe di isolamento
			
GU10 - Max 35 w (Ø50 L56m)	IP67	IK08	