

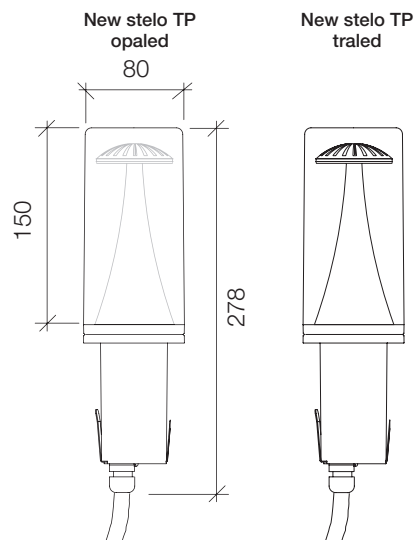

New stelo TP opaled • New stelo TP traled



CE Conforme alle direttive UE



Spessore max del palo 3mm

Dati tecnici

- Apparecchio led per utilizzo su pali Ø60mm spessore max 3mm
- Guarnizioni in silicone
- Dissipatore in alluminio anodizzato
- Circuito con n°12 led alimentato a 350mA e PCB in IMS (Insulated Metal Substrates) per aumentare la dissipazione termica e aumentare la robustezza meccanica del circuito
- Rischio fotobiologico RG1, Step Mac Adam 3, CRI ≥80
- Precablato 35cm di cavo in uscita dall'apparecchio H05RN-F 2x0,75mm²
- Pressacavo PG9 plastico con valvola osmotica anticondensa
- Molle di fissaggio in acciaio inox AISI 301
- Driver incluso
- Viteria in acciaio inox A2

Diffusore

- Diffusore in PMMA (acrilico) traslucido inalterabile ai raggi UV (New stelo TP opaled)
- Diffusore in PMMA (acrilico) trasparente inalterabile ai raggi UV (New stelo TP traled)

Cono

- Cono interno in PC (polycarbonato) colore nero

Fissaggio palo

- Fissaggio palo in PC (polycarbonato) colorato nero in pasta

Accessorio opzionale per l'installazione a parete (da ordinare separatamente)

- Accessorio per utilizzo a parete
- Staffa di fissaggio a parete in acciaio inox AISI 304

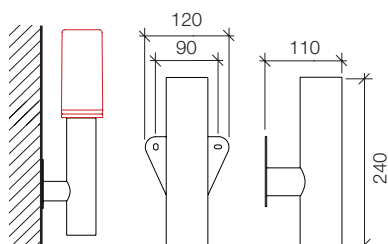

Accessorio per installazione a parete



New stelo TP opaled

Temperatura di colore	Gradi di protezione IP	IK	Classe di isolamento
 3000K  4000K			
3000K/4000K	IP65	IK02	

New stelo TP traled





Temperatura di colore	Gradi di protezione IP	IK	Classe di isolamento
 3000K  4000K			
3000K/4000K	IP65	IK06	

Accessorio opzionale per l'installazione a parete

Staffa fissaggio a parete
120x240x110mm

Codice 

1053.000N 1

Modello	K/Potenza/Flusso led effettivo	New stelo TP traled	New stelo TP opaled	
New Stelo TP traled	 4000K - 5,1W - 557lm  3000K - 5,1W - 525lm	1052.182N	--	1
New Stelo TP opaled	 4000K - 5,1W - 487lm  3000K - 5,1W - 525lm	--	1053.182N	1