

LORD 5 HP

Proiettore per interni ed esterni adatto per l'illuminazione di grandi aree ed impianti sportivi. Corpo in alluminio trafilato ossidato silver, staffa zincata, vetro temperato trasparente spessore 4 mm, guarnizione in silicone, driver elettronico 220-240V 50/60Hz. Prodotto in conformità alle vigenti norme EN / IEC 60598-1:2018.

Indoor and outdoor floodlight, suitable for large areas and sports areas. Silver Extruded oxidate aluminium body, zinc-coated bracket, 4 mm thick tempered transparent glass, silicon gasket, electronic driver 220-240V 50/60Hz. Manufactured in accordance with EN / IEC 60598-1:2018.



INSTALLAZIONE / INSTALLATION



Ball Test
DIN 18032-3



Dotazione

Cablaggio esterno tramite box di derivazione IP68.

Equipment

External wiring via IP68 junction box.



Δ LUMEN

3000°K (CRI >70) = **-5.28%**
 4000°K (CRI >70) = **standard**
 5000°K (CRI >70) = **+0.90%**
 5700°K (CRI >90) = **-18.14%**
 6500°K (CRI >80) = **-5.58%**

CARATTERISTICHE / MAIN FEATURES

LED | CE | 220 V_≈ 240 | -25°C / +45°C | IP65 | IK08 | RG0 | CRI >70 / CRI >90 | 3 step MacAdam | <7% flicker | L80-B20 >50.000h | L80-B50 >75.000h | A++

CODIFICA / CODING

Art.	+	Mod.	+ °K (CRI)	+ W. tot.	+ Options
8054		MR	3 = 3000°K (CRI >70)	500	GL = on/off
		CR	4 = 4000°K (CRI >70)	600	GM = 1-10v
		SR	5 = 5000°K (CRI >70)		GD = dali
		AR	6 = 6500°K (CRI >80)		GV = vetro infrangibile / shatterproof glass
		RR	7 = 5700°K (CRI >90)		GA = vetro acidato / acid-etched glass
		SV			

DIMENSIONI / DIMENSIONS

D1 | A: 600 | B: 165 | C: 455 | D: 315 | Kg: 22,2 | mc: 0,089 | 30 | 0,273 m²

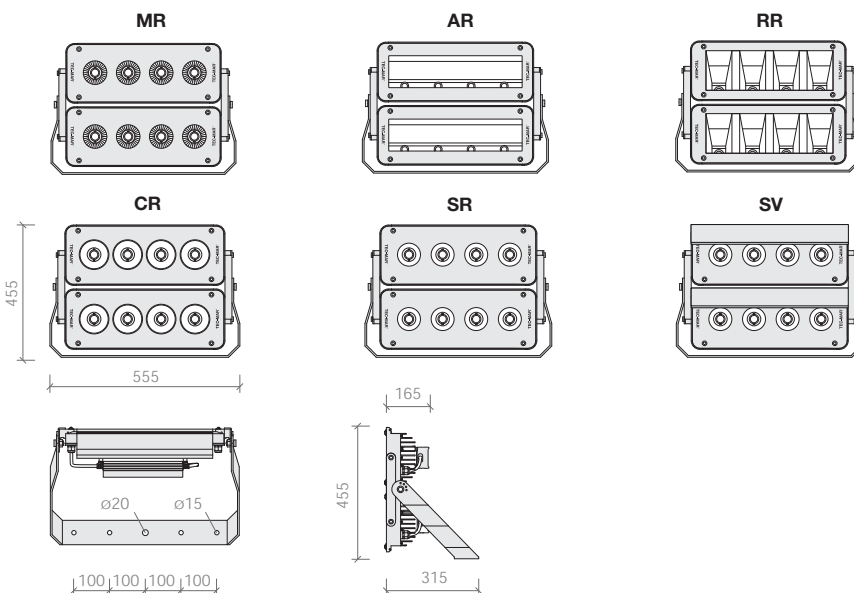



Mod. MR

Ottica

Riflettore simmetrico 70° in alluminio satinato

Optic

70° wide beam matt satin aluminium reflector

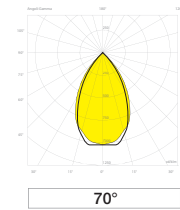

W tot.	°K - CRI	n° Led	LUMEN (Tj=85°)	LUMEN OUTPUT	Lm/W	replace	dimension
500	4000K - CRI>70	4+4	80728	67406	135	1000W JM/SAP	D1
600	4000K - CRI>70	4+4	93879	78180	130	1000W JM/SAP	D1



Mod. CR

Ottica

Riflettore concentrante 29° in alluminio satinato

Optic

29° narrow beam matt satin aluminium reflector

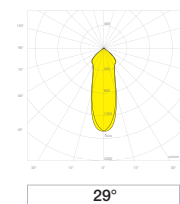

W tot.	°K - CRI	n° Led	LUMEN (Tj=85°)	LUMEN OUTPUT	Lm/W	replace	dimension
500	4000K - CRI>70	4+4	80728	70431	141	1000W JM/SAP	D1
600	4000K - CRI>70	4+4	93879	81688	136	1000W JM/SAP	D1



Mod. SR

Ottica

Riflettore concentrante 24° in alluminio satinato

Optic

24° narrow beam matt satin aluminium reflector

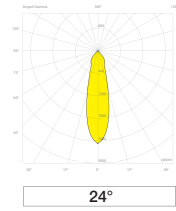

24°

W tot.	°K - CRI	n° Led	LUMEN (Tj=85°)	LUMEN OUTPUT	Lm/W	replace	dimension
500	4000K - CRI>70	4+4	80728	69567	139	1000W JM/SAP	D1
600	4000K - CRI>70	4+4	93879	80685	134	1000W JM/SAP	D1



Mod. AR

Ottica

Riflettore asimmetrico 55° in alluminio satinato

Optic

55° asymmetric beam matt satin aluminium reflector

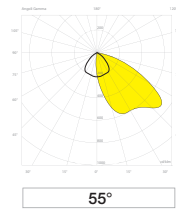

55°

W tot.	°K - CRI	n° Led	LUMEN (Tj=85°)	LUMEN OUTPUT	Lm/W	replace	dimension
500	4000K - CRI>70	4+4	80728	69135	138	1000W JM/SAP	D1
600	4000K - CRI>70	4+4	93879	80184	134	1000W JM/SAP	D1



Mod. RR

Ottica

Riflettore asimmetrico 65° in alluminio satinato

Optic

65° asymmetric beam matt satin aluminium reflector

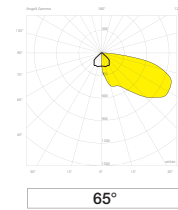

W tot.	°K - CRI	n° Led	LUMEN (Tj=85°)	LUMEN OUTPUT	Lm/W	replace	dimension
500	4000K - CRI>70	4+4	80728	66542	133	1000W JM/SAP	D1
600	4000K - CRI>70	4+4	93879	77177	129	1000W JM/SAP	D1



Mod. SV

Ottica

Riflettore concentrante 24° in alluminio satinato. Visiera con sistema anti-inquinamento luminoso in lamiera d'acciaio verniciato a colore.

Optic

24° narrow beam matt satin aluminium reflector. Anti-light pollution visor in color painted sheet steel.

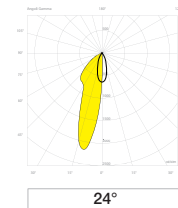

W tot.	°K - CRI	n° Led	LUMEN (Tj=85°)	LUMEN OUTPUT	Lm/W	replace	dimension
500	4000K - CRI>70	4+4	80728	49863	100	1000W JM/SAP	D1
600	4000K - CRI>70	4+4	93879	57833	96	1000W JM/SAP	D1

ACCESSORI / ACCESSORIES



ACC093 Kit Visiera anti-inquinamento luminoso per fasci concentranti con inclinazione <70°. Anti-pollution light visor kit for concentrated beams with inclination <70°.

ACC136 Cannocchiale di puntamento 4x32 per proiettori. 4x32 aiming scope for projectors.

ACC137 Laser di puntamento diurno e notturno per proiettori. Day and night aiming laser for projectors.