

# New Stelo TP Opaled + New Stelo TP Traled

## Technical details

- Led's luminaire for pole top use on Ø60mm poles with max thickness 3mm
- Silicone gaskets
- Anodized aluminium heat sink
- N°12 LED's and PCB in IMS
- A2 stainless steel screws
- Plastic PG9 cable gland with anti-condensation osmotic valve
- Stainless steel AISI 301 fixing clips for pole fixing
- Driver included

## Diffuser

- Non yellowing traslucent PMMA (acrylic) diffuser (New stelo TP opaied)
- Non yellowing transparent PMMA (acrylic) diffuser (New stelo TP traied)

## Cone

- PC (polycarbonate) diffuser cone in black granule

## Pole adapter

- PC (polycarbonate) pole adapter in black granule

## Optional accessory (to be ordered separately see pag. 235)



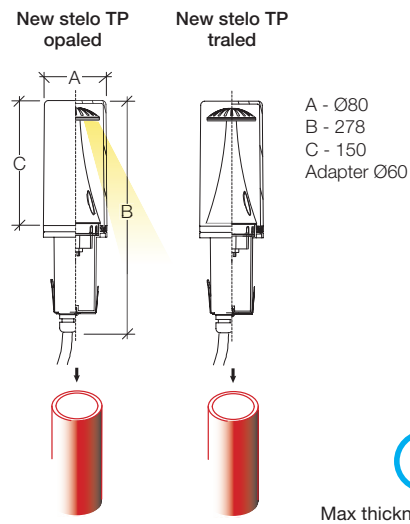







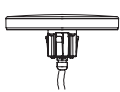



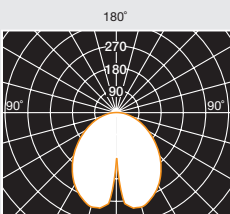
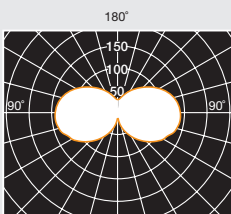
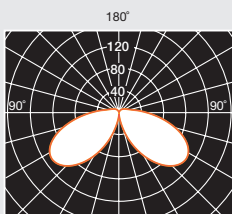
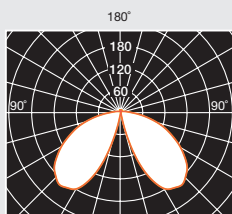















- Accessory for wall mounting
- Hot dipped galvanised steel bracket 75µm UNI EN 1461



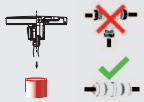
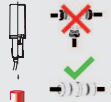

K/Power	New Stelo TP Traled	New Stelo TP Opaied	
● 4000K - 5,1W	1052.182N	1053.182N	1
● 3000K - 5,1W	1052.184N	1053.184N	1

new

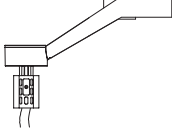
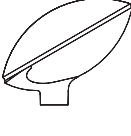
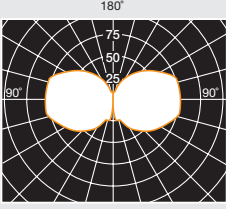
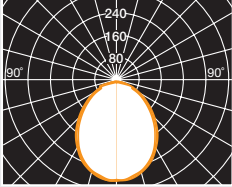
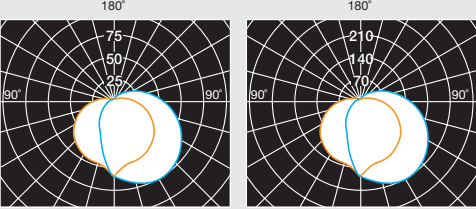
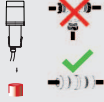

		Coled TP		New Stelo TP		New Stelo TP Opaed		New Stelo TP Traled	
									
									
Ground installation		✓		✓		✓		✓	
Wall installation		--		✓		✓		✓	
Complying ECC standards		✓		✓		✓		✓	
Insulation class		⊕		□		□		□	
Voltage		220-240V 50/60Hz		220-240V 50/60Hz		220-240V 50/60Hz		220-240V 50/60Hz	
Step MacAdam		3		--		3		3	
Life time		L70/B50>60Kh-Tc 105°C		--		L70/B50>60Kh-Tc 105°C		L70/B50>60Kh-Tc 105°C	
Colour temperature				--					
Luminaire output		15W 1518 lm	15W 1518 lm	--		5,1W 459 lm	5,1W 487 lm	5,1W 525 lm	5,1W 557 lm
Lamp holder		--		E27 - max 11W (lamp not included)		--		--	
IP (Protection degree)		IP65		IP65		IP65		IP65	
IK (Impact resistance)		IK05		IK02		IK02		IK06	
Year warranty		3		--		--		--	
Year warranty		--		5		5		5	
Photobiological risk		✓		--		✓		✓	
Pre-wired with:		100cm cable H05RN-F 3x0,75mm²		35cm cable H05RN-F 2x0,75mm²		35cm cable H05RN-F 2x0,75mm²		35cm cable H05RN-F 2x0,75mm²	
CRI		≥80		--		≥80		≥80	
Connector IP68 CS093000 (linear) and CS093001 ("T"-3 ways) not included									
		The "T"-3 ways IP68 connector cannot be placed inside the pole Ø60mm		The "T"-3 ways IP68 connector cannot be placed inside the pole Ø60mm		The "T"-3 ways IP68 connector cannot be placed inside the pole Ø60mm		The "T"-3 ways IP68 connector cannot be placed inside the pole Ø60mm	

# Technical details

 <b>Easy Lux TP</b>	 <b>Antera</b>	 <b>Tao</b>	
		 <b>30W - E27</b> <b>14,2W - Led</b>	
✓	✓	✓	
✓	--	--	
✓	✓	✓	
☐	⊕	☐	
220-240V 50/60Hz	220-240V 50/60Hz	220-240V 50/60Hz	
--	3	3	
--	L70/B50>60Kh-Tc 105°C		L70/B50>54Kh-Tc 85°C
--	● 3000K	● 4000K	● 3000K
--	15W 1007 lm	15W 1007 lm	14,2W 1644 lm
E27 - max 10W (lamp not included)	--		E27 - max 30W (lamp not included)
IP65	IP65		IP55
IK02	IK03		IK06
--	✓		✓
✓	--		--
--	✓		✓
35cm cable H05RN-F 2x0,75mm <sup>2</sup>	70cm cable H05RN-F 3x0,75mm <sup>2</sup>		--
--	≥80		≥80
 The "T"-3 ways IP68 connector cannot be placed inside the pole Ø60mm	 The "T"-3 ways IP68 connector cannot be placed inside the pole Ø60mm		 The "T"-3 ways IP68 connector cannot be placed inside the pole Ø60mm